

Article number: 12748000040110

Description: KLEE-coil 748 000 040.110
M4 Steel, zinc-pl. & chr. blue

Measures

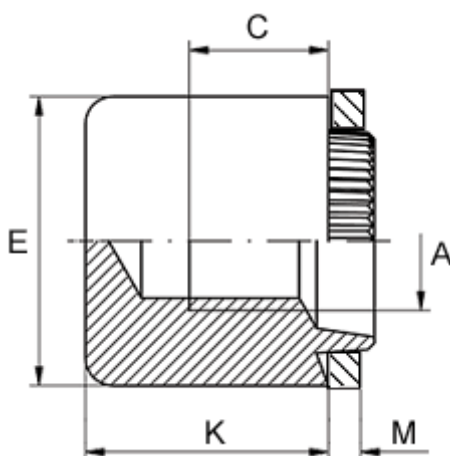

Female thread A	= M4
Height K	= 9.0
Min thread length C	= 4.0
Outer diameter E	= 10.0
Plate thickness	= 2.0 to 2.2
Recommended bore diameter for extreme load	= 7.0
Recommended bore diameter for normal use	= 7.0